

17.04.2011

Uttranchal Gramin RRB BANK OFFICER EXAM

REASONING

1. How many meaningful English words can be formed with the letters NCEO using each letter only once in each word ?

- (1) None (2) One
(3) Two (4) Three
(5) More than three

2. The positions of first and the fourth letters of the word LIQUID are interchanged, similarly, the positions of second and fifth letters and third and Sixth letters are interchanged. In the new arrangement thus formed, how many letters are there in the English alphabetical series between the alphabets which are at the extreme ends?

- (1) None (2) Two
(3) Three (4) Four
(5) More than four

Directions (3-4): Study the following information to answer the given questions :

Point P is 5 m towards the South of Point M. Point Q is 3 m towards the East of Point P. Point O is 3 m towards the East of Point M. Point N is 2 m towards the South of Point Q.

3. A person, facing North, takes a left turn from point M, walks 4m and stops. He then takes another left turn, walks 5 m and stops at point R. Which of the following points, including R, fall in a straight line ?

- (1) M, O, R (2) N, R, P
(3) R, O, Q (4) R, Q, N
(5) Q, P, R

4. How far and towards which direction is Point O from Point N ?

- (1) 5 m towards South
(2) 7 m towards North
(3) 8 m towards West
(4) 7 m towards West
(5) 5 m towards North

Directions (5-7): The following questions are based upon the alphabetical series given below:

T J E N U Q A K I O G R M S P
B H F D L V C

5. If 'OD' is related to 'GF' and 'EB' is related to 'NP' in a certain way, to which of the following is 'AL' related to, following the same pattern ?

- (1) KD (2) QV
(3) KL (4) KV
(5) DQ

6. What will come in place of question mark (?) in the following series based on the above alphabetical series?

- TE JU NK ? GH
(1) IS (2) IR
(3) AG (4) AR
(5) AM

7. If in a certain code 'GRIM' is coded as 'RMOS' and 'DUSK' is coded as 'LQPI' how will 'STOP' be coded in the same code language?

- (1) MJIS (2) PJGB
(3) JPIJ (4) MJGB
(5) PGJB

8. Among five friends, P, Q, R, S and T, each scored different marks in the examination. P scored more than Q but less than R. S scored more than only T. Who amongst the following scored the second highest marks?

- (1) P (2) Q
(3) R (4) S
(5) T

9. If each of the alphabets of the word MIRACLE is arranged in alphabetical order from left to right and then each vowel in the new word thus formed is changed to the next letter in the English alphabetical series and each consonant is changed to the previous letter in the English alphabetical series which of the following will be fifth from the right?

- (1) K (2) S
(3) F (4) E
(5) J

10. How many such pairs of letters are there in the word INCLUDE,

each of which has as many letters between them in the word (in both forward and backward directions) as they have between them in the English alphabetical order?

- (1) None (2) One
(3) Two (4) Three
(5) More than three

Directions (11-15) : In these questions, relationship between different elements is shown in the statements. The statements are followed by conclusions.

Give answer (1) if only Conclusion I is true.

Give answer (2) if only Conclusion II is true.

Give answer (3) if either Conclusion I or II is true.

Give answer (4) if neither Conclusion I nor II is true.

Give answer (5) if both Conclusions I and II are true.

11. Statements:

$A \geq E > I$; $E = O < U$

Conclusions : I. $A \geq U$
II. $U > I$

12. Statements:

$B < C = D \geq E$; $C < F$; $B \geq G$

Conclusions : 1. $F > E$
II. $G \geq E$

13. Statements:

$P = Q > R \leq S$; $Q < T \leq U$

Conclusions : I. $U \geq R$
II. $T < S$

14. Statements :

$H \geq J \geq I < K = L$

Conclusions: I. $I < H$
II. $L > I$

15. Statements:

$M > N = O \leq P$; $N > Q$; $P \leq R$

Conclusions : I. $M \geq Q$
II. $R \geq N$

Directions (16-20) : Study the following information to answer the given questions:

P, Q, R, S, T, V, W and X are seated in a straight line facing North. T sits fourth to the left of W.

Neither T nor W sits at the extreme end of the line. Only one person sits between X and R. Neither X nor R is an immediate neighbour of W. P sits second to the right of X. Only two people sit between P and S. Q is not an immediate neighbour of S.

- 16.** What is the position of V with respect to Q ?
 (1) Fifth to the right
 (2) Immediate neighbour
 (3) Second to right
 (4) Third to right
 (5) None of these
- 17.** Which of the following represents persons seated at the two extreme ends of the line?
 (1) S, R (2) Q, S
 (3) R, P (4) X, Q
 (5) V, X
- 18.** How many persons are seated between R and P ?
 (1) One (2) Two
 (3) Three (4) Four
 (5) None
- 19.** If T is related to V and Q is related to P in a certain way, to which of the following would X be related to following the same pattern?
 (1) Q (2) T
 (3) R (4) S
 (5) W
- 20.** Who amongst the following sits exactly in the middle of the persons who sits fifth from the left and the person who sits sixth from the right?
 (1) P (2) Q
 (3) T (4) S
 (5) V

Directions (21-25) : Study the following information to answer the given questions:

In a certain code 'support the other group' is written as 'ja pe la no' 'the mission gains support' is written as 'ke ja zi la', 'gains other than money' is written as 'fu no ho zi' and 'more support and money' is written as 're qi fuja' .

- 21.** What is the code for 'group' ?
 (1) ja (2) pe
 (3) la (4) no
 (5) Cannot be determined

- 22.** What does 'zi' stand for ?
 (1) mission (2) than
 (3) other (4) the
 (5) gains
- 23.** Which of the following may represent 'more than the group' ?
 (1) la qi ho pe
 (2) re la qi ho
 (3) re no la pe
 (4) pe ke qi la
 (5) qi ho la fu
- 24.** What is the code for 'mission' ?
 (1) la (2) zi
 (3) ke (4) ja
 (5) ke or la
- 25.** Which of the following may represent 'money matters more' ?
 (1) fue re bu
 (2) re bu qi
 (3) zi qi yo
 (4) yo fu no
 (5) la fu bu

Directions (26 - 32): Study the following information carefully and answer the given questions.

Nine friends A, B, C, D, E, F, G, H and K are sitting around a circle facing the centre. A sits second to left of D. K sits third to right of F. Neither K nor F is an immediate neighbour of A or D. G and H are immediate neighbours of each other. E sits third to right of H. B is not an immediate neighbour of F.

- 26.** What is the position of F with respect to the position of B ?
 (1) Second to the right
 (2) Third to the left
 (3) Second to the left
 (4) Third to the right
 (5) Sixth to the right
- 27.** Who amongst the following is an immediate neighbour of H ?
 (1) C (2) B
 (3) K (4) F
 (5) A
- 28.** Starting from A, if all the friends are made to sit in the alphabetical order in clockwise direction, the positions of how many (except A) will remain unchanged ?
 (1) None (2) One
 (3) Two (4) Three
 (5) Four
- 29.** H is related to C and B is related to E in a certain way. To whom amongst the following is G related following the same pattern ?

- (1) F (2) H
 (3) C (4) A
 (5) D

- 30.** What will come in place of the question mark ?
 DC DB DF DA
 (1) DG (2) DE
 (3) DH (4) DK
 (5) Either DK or DE
- 31.** Who sits third to the left of A?
 (1) H (2) G
 (3) C (4) F
 (5) B
- 32.** Which of the following pairs represents the immediate neighbours of C?
 (1) FH (2) AB
 (3) BD (4) EK
 (5) DF

Directions (33 - 37): Study the following arrangement carefully and answer the questions given below:

S F 3 U A * 7 M @ \$ Q 2 % 6 © 8 N R 1 5 & 9 L Z C # V 4 p W E

- 33.** If all the numbers are dropped from the above arrangement which of the following will be eleventh from the left end of the above arrangement ?
 (1) N (2) %
 (3) K (4) ©
 (5) &
- 34.** Four of the following five are alike in a certain way based on the positions in the above arrangement and so form a group. Which is the one that does not belong to that group ?
 (1) A * U (2) L9Z
 (3) #VC (4) K5N
 (5) \$Q@
- 35.** How many such symbols are there in the above arrangement, each of which is immediately preceded by a number and also immediately followed by a letter ?
 (1) None
 (2) One
 (3) Two
 (4) Three
 (5) More than three
- 36.** What will come in place of the question mark ?
 SF UA M@ " %6 5&
 (1) V4 (2) #V
 (3) LZ (4) 94
 (5) None of these

37. Which of the following is seventh to the right of the twentieth from the right end of the above arrangement ?
 (1) % (2) 5
 (3) Q (4) 8
 (5) K

Directions (38 - 40) : Each of the questions below consists of a question and two statements numbered I and II given below it. You have to decide whether the data provided in the statements are sufficient to answer the question. Read both the statements and

Give answer (1) if the data in Statement I alone are sufficient to answer the question, while the "data in-Statement II alone are not sufficient to answer the question.

Give answer (2) if the data in Statement II alone are sufficient to answer the question, while the data in Statement I alone are not sufficient to answer the question.

Give answer (3) if the data either in Statement I alone or in Statement II alone are sufficient to answer the question.

Give answer (4) if the data in both the Statements I and II are not sufficient to answer the question.

Give answer (5) if the data in both the Statements I and II together are necessary to answer the question.

38. Among Rohan, Samir, Farhan and Emi seated in a straight line facing North, who sits at the extreme right hand corner of the line?

- (I) Samir and Farhan are immediate neighbours of each other and Emi is not an immediate neighbour of Samir.
 (II) Emi sits second to the right of Samir and Rohan is not an immediate neighbour of Samir,

39. Point A is towards which direction of Point D?

- (I) Walking 10m in a straight line from Point D leads to Point A.
 (II) Point C is located exactly between Point A and Point D.

40. On which day of the month was the farewell scheduled in the hostel ?
 (I) The farewell was scheduled after the exams got over i.e. 23rd of that month and all the students left the hostel on 29th of the same month.
 (II) The warden of the hostel did not want to hold the farewell on or before 27th of that month due to certain administrative reasons.

Directions (41-50): In each of the questions given below which one of the five answer figures on the right should come after the problem figures on the left, if the sequence were continued ?

Problem Figures

Answer Figures

41. (1) (2) (3) (4) (5)

42. (1) (2) (3) (4) (5)

43. (1) (2) (3) (4) (5)

44. (1) (2) (3) (4) (5)

45. (1) (2) (3) (4) (5)

46. (1) (2) (3) (4) (5)

47. (1) (2) (3) (4) (5)

48. (1) (2) (3) (4) (5)

49. (1) (2) (3) (4) (5)

50. (1) (2) (3) (4) (5)

NUMERICAL ABILITY

Directions (51-55) : What will come in place of the question mark (?) in the following questions ?

51. $(72 - 748 \div 17)^2 = (?)^2 \times 4$
 (1) -12 (2) 18
 (3) -16 (4) 16
 (5) 14
52. $1\frac{3}{11} - 1\frac{1}{5} = ? - 2\frac{1}{10} + 1\frac{3}{4}$
 (1) $\frac{101}{220}$ (2) $\frac{97}{110}$
 (3) $\frac{93}{220}$ (4) $\frac{109}{110}$
 (5) None of these
53. $(0.027)^2 \div (0.09)^5 \times (0.0081) = (0.3)^{?+4}$
 (1) 0 (2) 3
 (3) 4 (4) -4
 (5) None of these
54. 35% of 44% of 1150 + 20% of 700 = ?
 (1) 317.1 (2) 327.6
 (3) 229.6 (4) 245.1
 (5) None of these
55. $\sqrt{256 \times 49} + (19)^2 + 11 = (?)^2$
 (1) 24 (2) $(454)^{1/2}$
 (3) 454 (4) 484
 (5) -22

Directions (56-60): What approximate value will come in place of the question mark (?) in the following questions (You are not expected to calculate the exact value.)

56. $18991 \div 91 \times 33 = ? \times 31$
 (1) 300 (2) 220
 (3) 190 (4) 250
 (5) 280
57. $\frac{1211}{91} + \frac{43}{2211} \times \frac{111}{399} = ?$
 (1) 110 (2) 140
 (3) 160 (4) 190
 (5) 220
58. $(11.01)^3 + (14.01)^2 - (19.01)^2 = ?$
 (1) 1170 (2) 1250
 (3) 1220 (4) 1280
 (5) 1120
59. $\sqrt{8888} \times \sqrt{4444} + \sqrt{2222} = ? \div 8$
 (1) 1020 (2) 1120
 (3) 1180 (4) 1140
 (5) 1060

60. 81% of 901 - 121 = ? - 41% of 699
 (1) 940 (2) 890
 (3) 860 (4) 800
 (5) 920

Directions (61-65) : What will come in place of the question mark (?) in the following number series ?

61. 12 35 40 63 68 (?)
 (1) 93 (2) 75
 (3) 73 (4) 91
 (5) None of these
62. 19 28 46 82 154 (?)
 (1) 298 (2) 254
 (3) 278 (4) 248
 (5) None of these
63. 655 484 351 256 199 (?)
 (1) 161 (2) 218
 (3) 180 (4) 171
 (5) None of these
64. 21 28 47 86 153 (?)
 (1) 244 (2) 266
 (3) 256 (4) 254
 (5) None of these
65. 1229 500 157 32 5 (?)
 (1) 4 (2) 2
 (3) -3 (4) -2
 (5) None of these

Directions (66-70): In the following questions two equations numbered I and II are given. You have to solve both the equations and

- Give answer If**
- (1) $x > y$
 (2) $x \geq y$
 (3) $x < y$
 (4) $x \leq y$
 (5) $x = y$ or the relationship cannot be established

66. I. $(6 + x)^2 = x^2 + 3x$
 II. $5y^2 + 3y + 4 = 4y^2 + 8$

67. I. $8x^2 - 121 = \sqrt{961}$
 II. $22y - 565 = 4y - 331$

68. I. $\frac{9}{\sqrt{x}} + 2\sqrt{x} = 5\sqrt{x} + \frac{4}{\sqrt{x}}$

- II. $y^3 - \frac{\left(\frac{4}{3}\right)^{7/2}}{\sqrt{y}} = 0$

69. I. $(125)^{1/3}x + \sqrt{529} = 423$
 II. $\sqrt{676y} - 140 = 1940$

70. I. $\frac{34}{\sqrt{x}} - \frac{12}{\sqrt{x}} = 4\sqrt{x}$
 II. $\frac{6\sqrt{y}}{16} - \frac{4\sqrt{y}}{16} = \frac{1}{2\sqrt{y}}$

71. The side of a square is twice the length of a rectangle of area 828 sq.cm. Perimeter of the rectangle is 118 cm. What is the perimeter of the square?
 (1) 184 cm.
 (2) 288 cm.
 (3) 144 cm.
 (4) Cannot be determined
 (5) None of these

72. Three athletes ran in a race. Speed of first athlete was three-fourth speed of second athlete.

Speed of third athlete was 1— times speed of second athlete. First athlete covered the distance of 300 metres in 50 seconds. How much distance would third athlete cover in 40 seconds?
 (1) 400 metres (2) 300 metres
 (3) 450 metres (4) 350 metres
 (5) None of these

73. Amit's present age is three years less than Jyoti's age after five years. The ratio between Jyoti's present age and Vipin's present age is 12: 25. Vipin is 10 years younger than Ajay who is presently 60 years old. What is Amit's present age?
 (1) 26 years
 (2) 21 years
 (3) 24 years
 (4) Cannot be determined
 (5) None of these

74. The largest and the second largest angles of a triangle are in the ratio of 4 : 3 respectively. Thej numeric value of the smallest angle of the triangle is three less than the square of six. What is the value of the largest angle of the triangle?
 (1) 90° (2) 78°
 (3) 84° (4) 80°
 (5) None of these

75. In a test Pramila scored 195 marks less than Rohit. Rohit scored 280 marks more than Preeti in same test. Preeti scored 205 marks less than Pawan. Pawan scored 1400 marks in the test. Highest marks of the test are 1500. What was Pramila's **approximate** percentage of marks?
 (1) 92 (2) 89
 (3) 81 (4) 85
 (5) 95

76. The angles of a quadrilateral are in ratio of 6 : 5 : 7 : 2. The largest angle of the quadrilateral is equal to the largest angle of a triangle. One of the angles of the triangle is 31°. What is the value of smallest angle of the triangle?
 (1) 29° (2) 31°
 (3) 23° (4) 27°
 (5) None of these

77. Sum of three numbers is equal to sum of the square of 18 and the cube of 7. Second largest number is (9)² more than 65. Largest number is equal to the sum of square of 22 and square of 4. What is the value of the lowest number?
 (1) 24 (2) 31
 (3) 21 (4) 34
 (4) None of these

78. Ram purchased an item for ₹ 45,000 and sold it at a loss of 10 percent. From that amount he purchased another item and sold it at a gain of 15 percent. What is his overall gain/loss in the whole deal?
 (1) Gain of ₹ 1,525
 (2) Loss of ₹ 1,575
 (3) Gain of ₹ 1,755
 (4) Loss of ₹ 1,755
 (5) None of these

79. Sum of five consecutive numbers of Set-A is 355. Sum of the four consecutive even numbers of Set-B is 292. What is the sum of the smallest even number of Set-B and the largest number of Set-A?
 (1) 144 (2) 143
 (3) 148 (4) 142
 (5) None of these

80. The simple interest accrued on a sum of a certain principal is

₹ 8,000 in four years at the rate of 10 p.c.p.a. What would be the compound interest accrued on that principal at the rate of 4 p.c.p.a in 2 years?

- (1) ₹ 1,458
 (2) ₹ 1,120
 (3) ₹ 1,320
 (4) ₹ 1,632
 (5) None of these

Directions (81-85) : Study the following graph carefully to answer the questions that follow »

AMOUNT EARNED (IN THOUSANDS) BY THREE DIFFERENT PERSONS IN SIX DIFFERENT MONTHS

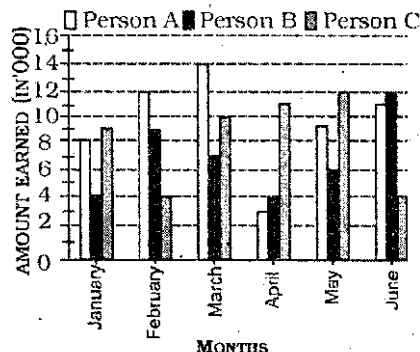

81. What was the percentage increase in amount earned by Person-C in March as compared to the previous month?

- (1) 145 (2) 150
 (3) 125 (4) 140
 (5) None of these

82. What was the average amount earned by Person-A in all the months together?

- (1) ₹ 8,520 (2) ₹ 9,520
 (3) ₹ 8,500 (4) ₹ 9,500
 (5) None of these

83. What was the respective ratio between the amount earned by Person-C in May, the amount earned by Person-A in March and amount earned by Person-B in April?

- (1) 6 : 7 : 2 (2) 7 : 2 : 6
 (3) 6 : 7 : 4 (4) 5 : 7 : 6
 (5) 5 : 7 : 3

84. What was the difference between the total amount earned by Person-B over all the months together and the amount earned by person-C in April?

- (1) ₹ 41,000 (2) ₹ 3.1 lacs
 (3) ₹ 48,000 (4) ₹ 31,000
 (5) None of these

85. Total amount earned by all the three persons together in January was **approximately** what percentage of the total amount earned by all the three persons together in March?

- (1) 62 (2) 81
 (3) 68 (4) 72
 (5) 78

Directions (86-90) : Study the table carefully to answer the questions that follow:

NUMBER OF SCIENCE AND ARTS STREAM STUDENTS IN FOUR DIFFERENT UNIVERSITIES IN FIVE DIFFERENT YEARS

University	A		B		C		D	
	Science	Art	Science	Art	Science	Art	Science	Art
2006	432	676	255	544	184	240	426	665
2007	743	654	338	123	148	528	736	220
2008	424	534	656	321	742	455	464	136
2009	645	408	732	124	454	502	502	222
2010	890	203	555	338	362	119	625	363

86. What was the average number of students from the University-B in arts stream over all the years together?

- (1) 269 (2) 290
 (3) 280 (4) 266
 (5) None of these

87. In which year was the difference between the number of Science and Arts students from University-D second highest?

- (1) 2006 (2) 2007
(3) 2008 (4) 2009
(5) 2010

88. Number of students in science stream from University-A in the year 2009 was **approximately** what percentage of the number of students in Arts streams from University-C in the year 2008 ?

- (1) 142 (2) 146
(3) 149 (4) 139
(5) 155

89. What was the respective ratio between the number of students in Science stream from University-C in the year 2007 and the number of students in Arts stream from the University-B in the year 2009 ?

- (1) 39 : 32 (2) 34 : 31
(3) .31 : 35 (4) 37 : 31
(5) 35 : 31

90. If 40 percent of the number of students in Arts stream from University-D in the year 2007 were males, what was the number of females in Arts stream from University-D in the year 2007 ?

- (1) 124 (2) 132
(3) 134 (4) 142
(5) None of these

Directions (91-95) : Study the following graph carefully to answer the questions that follow;

Number of tigers in three different sanctuaries in five different years

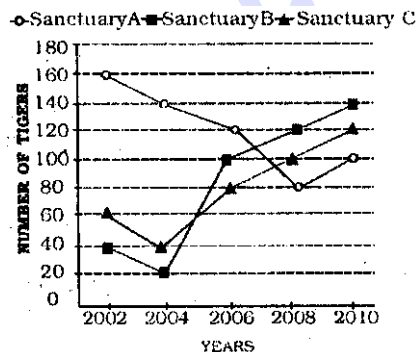

91. What was the total number of tigers in all the sanctuaries together in the year 2002 ?

- (1) 240 (2) 250
(3) 260 (4) 280
(5) None of these

92. What was the respective ratio between the total number of tigers in Sanctuary-A in the year 2006 and 2008 together and the number of tigers in Sanctuary-B in the year 2010?

- (1) 9 : 10 (2) 10 : 11
(3) 10 : 9 (4) 10 : 3
(5) None of these

93. Total number of tigers in Sanctuary-C over all the years together was **approximately** what percent of the total number of tigers in sanctuary-A in the year 2002 and 2008 together?

- (1) 174 (2) 167
(3) 161 (4) 156
(5) 151

94. What was the percent increase in the number of tigers in Sanctuary-B in the year 2006 as compared to the year 2004 ?

- (1) 300 (2) 600
(3) 500 (4) 400
(5) None of these

95. In which year was the total number of tigers in all the three sanctuaries together maximum?

- (1) 2002 (2) 2004
(3) 2006 (4) 2008
(5) 2010

Directions (96-100) : Study the following information carefully and answer the questions that follow:

In a state, Government recruited 4000 teachers for teaching five different subjects viz. Science, Mathematics, Hindi, Social Science and English. Fifteen percent of the total number of teachers are recruited for teaching Science. Three-tenth of the total number of teachers is recruited for teaching Mathematics. Teachers recruited for teaching Hindi are two-third of the number of teachers recruited for Mathematics. 12 percent of the remaining teachers are recruited for teaching Social Science. Rest of the teachers are recruited for teaching English.

96. What is the total number of teachers recruited for teaching Hindi and English together?

- (1) 1932 (2) 2042
(3) 2032 (4) 1942
(5) None of these

97. Number of teachers recruited for teaching Mathematics is **approximately** what percentage of the total number of teachers recruited for Hindi and Science together?

- (1) 72 (2) 74
(3) 78 (4) 82
(5) 86

98. What is the difference between the number of teachers recruited for teaching Social Science and the number of teachers recruited for teaching English?

- (1) 1144 (2) 1064
(3) 1024 (4) 1124
(5) None of these

99. If 42 percent of the total number of teachers recruited for teaching Science and Mathematics together is male. What is the total number of female teachers recruited for teaching Science and Mathematics together?

- (1) 1034 (2) 1064
(3) 1024 (4) 1044
(5) None of these

100. What is the respective ratio between the number of teachers recruited for teaching Social Science and the number teachers recruited for teaching of Mathematics?

- (1) 7 : 51 (2) 3 : 50
(3) 17 : 50 (4) 50 : 15
(5) None of these

GENERAL KNOWLEDGE

101. Who is the chairperson of National Advisory council?

- (1) Dr. C. Rangarajan
(2) Dr. Manmohan Singh
(3) Dr. Montek Singh Ahluwalia
(4) Mrs. Sonia Gandhi
(5) Mr. Pranab Mukherjee

102. Which of the following countries is maker of Audi' cars?

- (1) France (2) Japan
(3) UK (4) USA
(5) Germany

103. The 6th- Economic Census will be conducted in which of the following years?

- (1) 2011 (2) 2013
(3) 2012 (4) 2014
(5) 2015

- 104.** In order to strengthen the role of post offices in financial inclusion, which one of the following decisions has been taken by the Government?
- (1) Post Offices can open ATMs
 - (2) Post Office can enter into Private Public model
 - (3) Post Office should strengthen computerized framework
 - (4) Post Offices can appoint Sarpanch for providing basic services
 - (5) None of these
- 105.** Which of the following countries is NOT a member, of IBSA ?
- (1) India
 - (2) South Africa
 - (3) Brazil
 - (4) Argentina
 - (5) All are members of IBSA
- 106.** In which one of the following states Chinnaswamy stadium is located?
- (1) Karnataka
 - (2) Kerala
 - (3) Tamil Nadu
 - (4) Andhra Pradesh
 - (5) None of these
- 107.** India has decided to re-draw its borders with which one of the following countries?
- (1) Bangladesh
 - (2) Nepal
 - (3) Bhutan
 - (3) China
 - (5) None of these
- 108.** Ravi Bopara is associated with which of the following games/sports?
- (1) Tennis
 - (2) Hockey
 - (3) Cricket
 - (4) Badminton
 - (5) None of these
- 109.** To which one of the following countries cricketer Darren Bravo belongs ?
- (1) Ireland
 - (2) Canada
 - (3) Kenya
 - (4) West Indies
 - (5) Australia
- 110.** On which of the following countries the UNSC has recently imposed sanctions?
- (1) Yemen
 - (2) Egypt
 - (3) Bahrain
 - (4) Libya
 - (5) None of these
- 111.** What is correct description of Tejas ?
- (1) It is an indigenously built LCA
 - (2) It is a light aircraft acquired from Sweden
 - (3) It is a new frigate inducted in Indian Navy
 - (4) It is a surface to surface missile
 - (5) None of these
- 112.** Who is Kaushik Basu ?
- (1) Chief Economist GOI
 - (2) Chief Economic Advisor, GOI
 - (3) Chief Statistician, GOI
 - (4) Chairman Prime Minister's Economic Council
 - (5) None of these
- 113.** To get tribal welfare funds from the Planning Commission, which one of the following targets should be achieved by the Districts ?
- (A) Implementation of Forests Rights Act
 - (B) Strengthening of Panchayati Raj institutions
 - (C) Cent percent implementation of all the welfare programmes
- (1) Only (A)
 - (2) Only (B)
 - (3) Only (C)
 - (4) Only (A) & (B)
 - (5) All (A), (B) & (C)
- 114.** For inclusive growth and to alleviate poverty, which one of the following suggestions has been made in the current economic survey?
- (A) Create a National Forest Land Bank only
 - (B) Privatisation of State-run SEZs only
 - (C) Transfer of Cash directly to beneficiaries
- (1) Only (A)
 - (2) Only (B)
 - (3) Only (C)
 - (4) All (A), (B) & (C)
 - (5) Only (B) & (C)
- 115.** Which of the following is True about the 'Universal Banking System' a concept which has taken shape in India in recent past?
- (A) Universal banking means a mix of commercial banking and investment banking.
 - (B) Universal banking means providing opportunity to bank with any bank in the world at any moment of time.
 - (C) Universal banking means only one or two major banks in the country providing all sorts of services to their clients.
- (1) Only (A)
 - (2) Only (B)
 - (3) Only (C)
 - (4) Only (A) & (B) both
 - (5) None of these
- 116.** Which of the following Acts is introduced specially to combat financing of terrorism and other illegal activities?
- (1) Banking Regulation Act
 - (2) Anti Money Laundering Act
 - (3) Fiscal Responsibility and Budget Management Act
 - (4) Foreign Exchange Management Act
 - (5) None of these
- 117.** Which of the following Indian Companies has entered into a deal to acquire Sheel's Stanlow refinery ?
- (1) RIL
 - (2) ONGC
 - (3) Essar Energy
 - (4) GAIL
 - (5) None of these
- 118.** Expand the term MGNREGA.
- (1) Mahatma Gandhi National Rural Employment Guarantee Agency
 - (2) Mahatma Gandhi National Rural Employment Guarantee Act
 - (3) Mahatma Gandhi New Rural Employment Guarantee Act
 - (4) Mahatma Gandhi National Rural Empowerment Guarantee Agency
 - (5) None of these
- 119.** Which one of the following is the objective of Rajiv Awas Yojana ?
- (1) To make rural areas slum free
 - (2) To make semi urban areas slum free
 - (3) To make cities slum free across the country
 - (4) To provide affordable houses to the people across the country
 - (5) To provide economical housing to Central Govt, employees
- 120.** Which one of the following makes recommendations in respect of non-tax revenue in the Union Budget ?
- (1) Department of Expenditure
 - (2) Department of Economic Affairs

- (3) Department of Revenue
(4) Planning Commission
(5) None of these
- 121.** What is an 'Aadhaar' ?
(1) It is the scheme by which unique number is issued by UIDAI to all Indian citizens
(2) It is a mid-day meal programme for schools
(3) It is a programme to provide food subsidy to people living below poverty line
(4) It is a programme meant for rural development
(5) None of these
- 122.** Which one of the following keeps a tab on accounts of the Govt, of India?
(1) The Planning Commission
(2) The Comptroller and Auditor General
(3) Joint Parliamentary Committee
(4) Department of Expenditure
(5) None of these
- 123.** In which one of the following states, Posco Steel project is proposed to be set up ?
(1) Bihar (2) West Bengal
(3) Orissa (4) Jharkhand
(5) None of these
- 124.** On which one of the following days does the Finance Minister present the Union Budget in the Lok Sabha?
(1) In the last week of Feb
(2) On the last day of Feb
(3) On the last working day of Feb
(4) In the last fortnight of Feb
(5) None of these
- 125.** In which one of the following currencies, India has decided to make payment to buy crude oil from Iran?
(1) Pound Sterling
(2) Euro
(3) Yuan
(4) Yen
(5) None of these
- 126.** Who is KG Balkrishnan ?
(1) Chairman, National Human Rights Commission
(2) Chief Justice, Supreme Court
(3) Member, Planning Commission
(4) Australian Cricket Team Captain
(5) None of these
- 127.** Who is Haroon Lorgat?
(1) Chief Executive, ICC
(2) President, ICC
(3) English Cricket Team Captain
(4) Australian Cricket Team Captain
(5) None of these
- 128.** As proposed in the current Railway Budget on attaining which of the following age (in years), Indian women can enjoy benefits of Senior Citizen concessions, while travelling in Indian railways?
(1) 55 (2) 56
(3) 57 (4) 58
(5) 60
- 129.** The concept of providing banking services to the poor and those staying in remote unbanked areas, is popularly known as—
(1) Small Loan Accounts
(2) Savings Bank Accounts
(3) Investment Banking
(4) Financial Inclusion
(5) SME Finance
- 130.** India is not associated with which of the following organizations?
(1) SAARC (2) OPEC
(3) BRIC (4) WTO
(5) World Bank
- 131.** Who is Ms. Meira Kumar?
(1) Chairperson Women Commission of India
(2) Deputy Finance Minister of India
(3) Deputy Minister for Home Affairs
(4) India's Representative in IMF
(5) Speaker of the Lok Sabha
- 132.** Which of the following terms is used in Economics?
(1) Plasma
(2) Coulomb's Law
(3) Achromatic
(4) Demand & Supply
(5) Pulse Rate
- 133.** Which of the following awards is given for achievement in the field of literature?
(1) Arjuna Award
(2) Paramvir Chakra
(3) Kalinga Award
(4) Oscar Award
(5) Booker Prize
- 134.** Which of the following is an employment generating programme of the Govt, of India?
(1) ASHA
(2) Pulse Polio
(3) Janani Suraksha
(4) SJGSY
(5) Midday Meal
- 135.** Under Bharat Nirman, the plan was set up to provide road connectivity to all villages by the year—
(1) 2008 (2) 2009
(3) 2010 (4) 2011
(5) 2015
- 136.** Under Indira Gandhi National Old Age Pension Scheme (IGNOAPS), the benefits are given to the people with a minimum age of:
(1) 50 years (2) 55 years
(3) 65 years (4) 60 years
(5) None of these
- 137.** The World Health Organisation (WHO) has declared which of the following diseases as a 'Global Pandemic' ?
(1) Swine Flu (2) AIDS
(3) Polio (4) Malaria
(5) All of these
- 138.** Which Central Body controls the development and management of ground water resources in India?
(1) Central Water Commission
(2) National Water Board
(3) National Water Resources Council
(4) National River Board
(5) None of these
- 139.** Under the Right to Education Bill, children of which one of the following age groups are eligible to get free education?
(1) Upto five years
(2) Six to eight years
(3) Six to fourteen years
(4) Ten to twelve years
(5) None of these
- 140.** In which one of the following states, Teesta Urja hydro-power project is proposed to be set up ?
(1) Sikkim
(2) Arunachal Pradesh
(3) Meghalaya
(4) Manipur
(5) Assam
- 141.** Which of the following books is written by Vikram Seth?
(1) City of Joy
(2) A New World
(3) Living History
(4) Two Lives
(5) None of these

RRB BANK OFFICER EXAM

GENERAL ENGLISH

142. Which of the following is the book written by Anita Desai ?
 (1) Magic Seeds
 (2) My God Died Young
 (3) The Village By the Sea
 (4) My India
 (5) Red Earth and Pouring Rain
143. China proposes to lay a 1100 km. long gas and oil pipeline to link it with which one of the following nations ?
 (1) UAE (2) Bangladesh
 (3) Kuwait (4) Iraq
 (5) None of these
144. According to World Bank projections, the GDP growth of India during 2010 will be at the rate of— .
 (1) 6% (2) 6.5%
 (3) 5.5% (4) 12%
 (5) None of these
145. According to the new data, which one of the following represents the contribution of Service Sector to the total GDP of the nation?
 (1) 48% (2) 15%
 (3) 10% (4) 70%
 (5) None of these
146. Which, of the following terms is NOT associated with Agriculture?
 (1) Arid climate
 (2) Aquaculture
 (3) Total Ionic Equation
 (4) Commodity Certificates
 (5) Contract Acreage
147. Which of the following currencies is the official currency of Kuwait?
 (1) Euro (2) Dirham
 (3) Taka (4) Dollar
 (5) Dinar
148. Which of the following trophies cups is associated with the game of Hockey?
 (1) Dhyanchand Trophy
 (2) DavteCup
 (3) Ranji Trophy
 (4) JDCM Cup
 (5) None of these
149. Ashwini Akkunjji's name is associated in the field of—
 (1) Cinema
 (2) Literature
 (3) Sports
 (4) Space Research
 (5) Politics
150. What is Repo Rate at present?
 (1) 5% (2) 5.5%
 (3) 4% (4) 4.5%
 (5) None of these

Directions (151-160): In the following passage there are blanks, each of which has been numbered. These numbers are printed below the passage and against each, five words/phrases are suggested, one of which fits the blank appropriately. Find out the appropriate word/phrase in each case.

The children living in rural areas continue to be deprived of a quality education. Part of the reason is their teachers. A large number of teachers (151) to teach in rural areas and those that do are usually under qualified. In recent years the number of qualified teachers has increased because of (152) efforts by the government and private groups to (153) the general education and professional training of teachers. There is more of an emphasis on the training of rural teachers, whose educational backgrounds are generally not as (154) as their urban counterparts. Those that refuse to teach in rural areas (155) distance and lack of interest by students as problems. Many of the teachers also (156) the enthusiasm to teach because of their meagre salary. Another obstacle (157) by the schools is that obtaining more teachers for rural schools is difficult because of state guidelines that approve of high student-to-teacher ratios.

As the lack of teachers creates many obstacles for children in rural schools, another (158) is the lack of resources which becomes detrimental to the learning process. Lack of books and other reading materials seems to be a widespread problem. The use of high-tech devices such as computers is (159) rare. Another condition of the schools is the inadequate facilities in the classes that are actually (160) in. Some schools are located in warehouses while others in small houses. Many of the rural schools operate without electricity.

151. (1) reject (2) averse
 (3) gear (4) refuse
 (5) adamant
152. (1) none (2) most
 (3) increased (4) dire
 (5) enlarged
153. (1) improve (2) recover
 (3) decrease (4) advanced
 (5) progressive

154. (1) exhausted (2) sound
 (3) cheap (4) qualified
 (5) limited
155. (1) say (2) lilt
 (3) reduce (4) cite
 (5) make
156. (1) use (2) loose
 (3) little (4) have
 (5) lack
157. (1) faced (2) feature
 (3) witness (4) born
 (5) looked
158. (1) benefit (2) problem
 (3) issues (4) hinder
 (5) setback
159. (1) so (2) much
 (3) very
 (4) extraordinary
 (5) many
160. (1) sit (2) taught
 (3) skilled (4) train
 (5) qualified

Directions (161-165): Which of the phrases (1), (2), (3) and (4) given below each sentence should replace the word/phrase printed in **bold** in the sentence to make it grammatically correct? If the sentence is correct as it is given and no correction is required, mark (5) as the answer.

161. When actor-turned-politician paid a visit to her school to attend its ruby celebration recently, little did she know she'd take home **the most memorable** experiences of her life.
 (1) most memorable **experience**
 (2) more memorable ex; . iences
 (3) one of the most memorable experience
 (4) memorable experience
 (5) No correction required
162. The guests **were witnessed to have** a gala time, with most of them tapping their feet to tire loud music.
 (1) witnessed has
 (2) were witnessed having
 (3) was witnessing to have
 (4) were, witnessed
 (5) No correction required
163. Without trust, any relationship will **not be last** long.
 (1) not last
 (2) no lasting
 (3) not lasting
 (4) not lasted
 (5) No correction required
164. Blue and white lights adorning all sides of the venue looked just **as welcomed than** the gorgeous din-

ner setting and the huge dance floor.

- (1) so welcomed as
(2) as welcoming as
(3) so welcome as
(4) as welcoming so
(5) No correction required

165. The IJniversity cancelled the exam within ten minutes of it starting after it was discovered that the question paper **been leaked**.

- (1) is being leak
(2) is leaked
(3) had been leaked
(4) was leaking
(5) No correction required

Directions (166-170): Rearrange the following five sentences (A), (B), (C), (D) and (E) in the proper sequence to form a meaningful paragraph; then answer the questions given below them.

- (A) These inhibitors to providing profitable mobile services to rural India come from two main sources-
(B) Rural India has a massive pent-up derhand for mobile services; a limitless supply of low-cost labour to help deploy them; and a large entrepreneurial class ready to deliver services at the local level.
(C) As powerful as these market drivers may be, the inhibitors are even more formidable.
(D) Firstly, there are the inherent constraints of the market — its geography, economy and skill levels; and secondly, the inherent limitations of current GSM technology, processes and models.
(E) Cheap handsets are available and, unlike urban locations space for Base Stations is plentiful.

166. Which of the following should be the **FIRST** sentence after rearrangement?

- (D) A (2) B
(3) C (4) D
(5) E

167. Which of the following should be the **SECOND** sentence after rearrangement?

- (1) E (2) D
(3) C (4) B
(5) A

168. Which of the following should be the **THIRD** sentence after rearrangement?

- (D) A (2) B
(3) C (4) D
(5) E

169. Which of the following should be the **FOURTH** sentence after rearrangement?

- (D) A (2) B
(3) C (4) D
(5) E

170. Which of the following should be the **FIFTH** sentence after rearrangement?

- (1) A (2)
(3) C (4) D
(5) E

Directions (171-175) : Each question below has two blanks, each blank indicating that something has been omitted. Choose the set of words for each blank which best fits the meaning of the sentence as a whole.

171. I carved a _____ for myself in the political field and gained _____ and acceptance because of my efforts and not for what my mother and grandfather had done.

- (1) niche-respect
(2) place-pace
(3) sculpture-popularity
(4) rock-adulation
(5) function-trouble

172. Long distance relationships can be very _____ as you don't have to tell your partner where you are or what are you doing all the time _____ it can also make a person depressed, aloof and isolated.

- (1) liberating-but
(2) trying - and
(3) healing - since
(4) difficult - although
(5) alarming - then

173. The department had _____ a circular to all the other department heads requesting them to check if the file was _____ received by them.

- (1) posted - quickly
(2) issued - inadvertently
(3) sent - erroneously
(4) notified - mistakenly
(5) hosted - wrongly

174. Even though the regional transport authority is all set to make _____ by meter mandatory for auto rickshaws, the three-wheeler drivers have _____ a ban on illegal transport vehicles plying in city limits.

- (1) going - witnessed
(2) running - ruled
(3) driving-thwarted
(4) plying - demanded
(5) paying - said

175. The discovery of _____ cave, has _____ to the city's history of subterranean structures.

- (1) further - included
(2) another - added
(3) extra - supplemented
(4) more - contributed
(5) few - gone

Directions (176-185): Read each sentence to find out whether there is any grammatical error or idiomatic error in it. The error, if any, will be in one part of the sentence. The number of that part is the answer. If there is no error, the answer is '5'. (Ignore errors of punctuation, if any).

176. As the clock struck twelve, (1)/ we heard the big bang of the fire crackers (2)/and see all the guests screaming (3)/shouting and wishing each other with joy.(4)/No error (5)

177. With several modes of (1)/communication available today, (2)/you and your partner can email, (3) /text and call each other whenever you want. (4)/No error (5)

178. One of the oldest clubs in the city, (D/it has, once again, proved that when it comes to (2)/celebrations, nothing can beat the arrangements (3)/that greet guests for the venue. (4)/No error (5)

179. The university has ordered (1)/an inquiry into the leak and formed (2) / an inquiry committee who will have to (3)./ submit its primary report within 48 hours. (4)/No error (5)

180. Despite complaints (1)/the authorities have (2)/failed to take any action (3)/against illegal vehicles. (4)/ No error (5)

181. The structure overlooks (1)/the valley and is (2)/very hardly noticeable (3)/from the busy highway. (4)/No error (5)

182. Ever so often, all professional employees (D/get caught up with meeting demands(2)/to achieve professional goals (3)/and neglect their personal lives. (4)/No error. (5)

183. A small depression can (1)/ be seen in the centre of the single cell cave, (2)/which can accommodate (3)/a few peoples. (4)/No error (5)

184. Not only should professionals set (1)/a personal time for themselves, (2)/they should also treat it as seriously (3)/as they would treat their work time. (4)/No error (5)

185. We all have been through (1)/the bitter-sweet struggle of balancing (2)/the demands of our career (3)/with those on our families. (4)/No error (5)

Directions (186 - 200): Read the following passage carefully and answer the questions given below it. Certain words/phrases have been printed in **bold** to help you locate them while answering some of the questions.

A "symbiotic relationship" is how the chairman of a leading soft drink company describes the work that the food and beverage multinational undertakes with thousands of farmers across India. "We help them with progressive farming techniques and they are of huge benefit to us in **securing** a reliable supply chain," he says. Some observers would term this as corporate social responsibility (CSR); others more cynically might say it's simply another example of multinational corporations (MNCs) trying to figure out how to make inroads in India's challenging, but potentially **lucrative** rural market.

Whatever the words used by executives for such initiatives, it is impossible to discuss multinational strategies in rural India without mentioning CSR. In its various forms, it is a critical part of their rural growth plans, often out of sheer necessity. Filling the gaps left by government, MNCs have built roads in rural India that help them deliver their goods, provide education and health care for communities whose workforces they rely upon, and implement environmental programs to protect precious natural resources needed to keep supply chains running smoothly.

"In some cases, I am sure CSR activities are mostly **rhetoric**," says a management professor. "But CSR is more legitimate in India than in the U.S., where infrastructure has been built and government is seen as addressing social development agendas."

Yet now there's a shift in how MNCs look at their entire rural India investments beyond CSR. With growth drying up in developed markets and their centre of gravity shifting to emerg-

ing markets, MNC businesses in India are under pressure to prove that their rural strategies aren't just about doing well from a CSR perspective. They also need to show head office that these strategies are doing well from a business perspective. In short, the strategies must start delivering top-and bottom-line results.

For many MNCs, there's a lot more riding on their rural India performance than there once was as India's growth story spreads to the heartland. Two-thirds of the country's one billion consumers live in rural India, where almost half of the national income is generated. A report by a trade body estimates that the country's rural consumer market generated US\$425 billion of revenue, up from US\$266 billion the previous year. The big reason for the growth is that India's rural consumers are steadily gaining more spending power. The number of rural households earning less than US\$760 a year is down from 65% to 24% since 1993, while those with an income of US\$1,525 have more than doubled from 22% to 46%. Combine these factors with improved roads and other infrastructure in rural India to help products reach their markets, and it's easy to see rural India's attraction.

But any company coming to India for the first time that thinks it will be easy to take advantage of that combination is mistaken. Rural India is hugely complex, not least because of its diverse pace of development. As a recent study from a research company in Mumbai notes, some markets are big but not as affluent as other markets while some are affluent but not very large. Experts also say that strategies need to take into account the vast number of languages and cultural differences across India's hinterland, while keeping strategies highly flexible and adaptable. It can mean developing products and services tailored specifically to the rural market. Much also depends on the sector and products sold. In fast-moving consumer goods, for example, MNC products are capturing a **sizable** portion of rural consumer spending in a number of areas, with year-on-year increases in rural spending in 2009 on MNC products. What's more, the average spending on these products is growing faster in rural than in urban markets.

In the course of ramping up the performance of their rural strategies,

MNCs are applying the lessons already learned. One of those lessons is that the benefits of a first-ciover advantage are tough to hang on to **jis** rural Indian consumers' tastes change rapidly, with questionable brand loyalty. While other MNCs aren't necessarily going to be **airing** their competitive grievances in court, they can expect fast, nimble competitors to take them by surprise and grab market share if they don't stay close to their customers — which is no small **feat** in a country like India, which has 642,000 villages, some with populations as low as 500.

Nowhere is that more evident than in mobile telephony. Mobile phone penetration in India jumped from 1.4 units per 100 people in 1995 to 51 units currently. In the 12 months to September 2009, the number of mobile subscribers increased 55% to 142 million, according to the Telecommunications Regulatory Authority of India. But it's a crowded business to be in. There are a number of handset makers not only from China selling cut-price handsets, but also from India's home-grown companies that are chipping away at the market share with handsets that are cheaper, more practical or both.

186. Why does the author say that the mobile phone industry is crowded?

- (1) The Telecommunications Regulatory Authority of India has imposed too many restrictions on the market players.
- (2) The different market players try to sell their wares through fierce advertising and thus compel people into not buying.
- (3) Too many people want to buy mobile phones and there is not enough supply of the same in the market.
- (4) There are many market players or competitors who sell wares at extremely low prices.
- (5) None of these

187. Which of the following **best** describes the relationship between multinationals and farmers in the passage?

- (1) Futuristic
- (2) Lopsided
- (3) Give and take
- (4) Strained
- (5) One-sided

- 188.** Why, according to the author, will new companies coming to India find it difficult to take advantage of the rural market?
- (A) Products have to be specifically customized for the rural population
- (B) Rural markets are either large - but do not have much buying power or have the buying power but are small
- (C) Development in rural India is not uniform
- (1) Only (B)
- (2) Only (A) and (C)
- (3) Only (C)
- (4) Only (A) and (B)
- (5) All (A), (B) and (C)
- 189.** Which of the following is **true** in the context of the passage?
- (1) There has been an increase of nearly 60 percent in the number of urban consumers.
- (2) Less than 30 percent of consumers live in rural areas.
- (3) Poor infrastructure in rural areas acts as a deterrent to MNCs-setting up shop there.
- (4) Rural India contributes to half of the nation's income.
- (5) There is not much change in the income levels in the rural areas over the past 18 years.
- 190.** Which of the following is possibly the most appropriate title for the passage?
- (1) India and Industriousness
- (2) The Elite Rural India
- (3) Selling to Rural India
- (4) Rural India's Monetary Problems
- (5) Basics of Marketing
- 191.** Which of the following is/are reason/s for MNCs shifting their focus towards rural areas?
- (A) There is lesser demand in the urban market.
- (B) They want to strategize beyond corporate social responsibility in order to deliver results.
- (C) They have been asked by the government to pay more attention to the rural sector.
- (1) Only (A) and (C)
- (2) Only (A) and (B)
- (3) Only (A)
- (4) Only (B) and (C)
- (5) All (A), (B) and (C)
- 192.** Which of the following is/are advantage/s of the intervention of MNCs in rural areas?
- (A) There is increased conservation of natural resources through environmental programmes.
- (B) There is an improvement in education levels and health care facilities of worker communities.
- (C) Roads in rural areas have improved
- (1) Only (A) and (C)
- (2) Only (A) and (B)
- (3) Only (A)
- (4) Only (B) and (C)
- (5) All (A), (B) and (C)
- 193.** What is the tone of the author in the passage?
- (1) Critical (2) Implicative
- (3) Urgent (4) Factual
- (5) Ironic
- Directions (194-197):** Choose the word/group of words which is **most similar** in meaning to the word/group of words printed in **bold** as used in the passage.
- 194. FEAT**
- (1) task (2) charge
- (3) trick (4) deception
- (5) performance
- 195. AIRING**
- (1) breaching (2) voicing
- (3) ventilating (4) drying
- (5) opening
- 196. RHETORIC**
- (1) style (2) language
- (3) lip-service (4) question
- (5) troublesome
- 197. SECURING**
- (1) acquiring (2) locking
- (3) bolting (4) fastening
- (5) catching
- Directions (198-200):** Choose the word/group of words which is **most opposite** in meaning to the word/group of words printed in **bold** as used in the passage.
- 198. DRYING-UP**
- (1) freshening up
- (2) liquidating (3) soaking
- (4) wilting (5) picking up
- 199. SIZABLE**
- (1) different (2) minuscule
- (3) invisible (4) hidden
- (5) ample
- 300. LUCRATIVE**
- (1) unprofitable (2) casual
- (3) unrealistic (4) beneficial
- (5) coarse

ANSWERS

1.(3)	2. (3)	3. (5)	4.(2)
5. (1)	6.(4)	7. (2)	8.(1)
9. (3)	10. (5)	11. (2)	12.(1)
13. (4)	14. (5)	15. (2)	16. (4)
17. (1)	18. (3)	19. (5)	20. (2)
2-1. (2)	22. (5)	23. (1)	24. (3)
25. (1)	26. (4)	27. (4)	28. (2)
29. (1)	30. (3)	31. (2)	32. (5)
33. (4)	34. (2)	35. (2)	36.(1)
37. (5)	38. (5)	39. (4)	40. (5)
41. (3)	42. (4)	43. (2)	44.(1)
45. (5)	46. (3)	47. (4)	48. (5)
49. (1)	50.(1)	51. (5)	52. (3)
53. (4)	54. (1)	55. (5)	56. (2)
57. (4)	58. (1)	59. (5)	60. (2)
61. (4)	62. (1)	63. (3)	64. (3)
65. (1)	66. (4)	67. (3)	68. (1)
69. (5)	70. (1)	71. (4)	72. (1)
73. (1)	74. (3)	75. (4)	76. (3)
77. (3)	78. (5)	79. (2)	80. (4)
81. (2)	82. (4)	83. (1)	84. (4)
85. (3)	86. (2)	87. (3)	88. (1)
89. (4)	90. (2)	91. (3)	92. (5)
93. (2)	94. (4)	95. (5)	96. (3)
97. (5)	98. (2)	99. (4)	100. (5)
101. (4)	102. (5)	103. (3)	104. (1)
105. (4)	106. (3)	107. (4)	108. (3)
109. (4)	110. (4)	111. (1)	112. (2)
113. (5)	114. (3)	115. (3)	116. (2)
117. (3)	118. (2)	119. (3)	120. (3)
121. (1)	122. (2)	123. (3)	124. (3)
125. (2)	126. (1)	127. (1)	128. (4)
129. (4)	130. (2)	131. (5)	132. (4)
133. (5)	134. (4)	135. (2)	136. (4)
137. (1)	138. (3)	139. (3)	140. (1)
141. (4)	142. (3)	143. (2)	144. (5)
145. (5)	146. (4)	147. (5)	148. (1)
149. (3)	150. (5)	151. (4)	152. (3)
153. (1)	154. (2)	155. (4)	156. (5)
157. (1)	158. (5)	159. (3)	160. (2)
i 6i: (i)	162. (5)	163. (1)	164. (3)
165. (3)	166. (2)	167. (1)	168. (3)
169. (1)	170. (4)	171. (1)	172. (1)
173. (3)	174. (4)	175. (2)	176. (3)
177. (5)	178. (4)	179. (3)	180. (5)
181. (2)	182. (2)	183. (4)	184. (4)
185. (4)	186. (4)	187. (3)	188. (5)
189. (4)	190. (3)	191. (3)	192. (5)
193. (4)	194. (1)	195. (2)	196. (3)
197. (1)	198. (5)	199. (2)	200.(1)

EXPLANATIONS

1. (3) Meaningful Words ⇒ CONE, ONCE

2. (3) U I D L I Q

U T S R Q

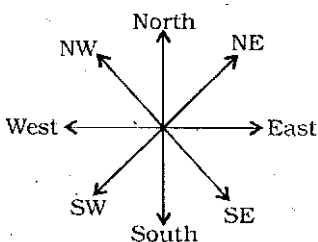
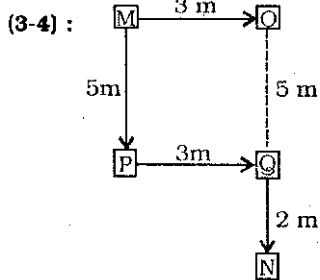

3. (5)

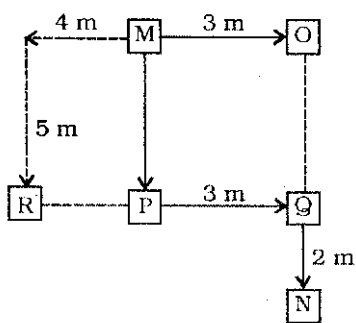

Points R, P and Q are in a straight line.

4. (2) Point O is 7 metres towards North of Point N.

5. (1) $O \xrightarrow{+1} G$ $E \xrightarrow{+1} N$

$D \xrightarrow{-1} F$ $B \xrightarrow{-1} P$

Similarly,

$A \xrightarrow{+1} K$

$L \xrightarrow{-1} D$

6. (4)

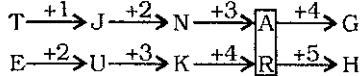

7. (2)

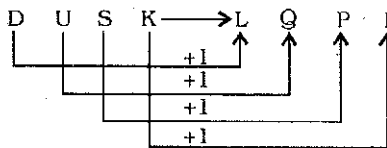
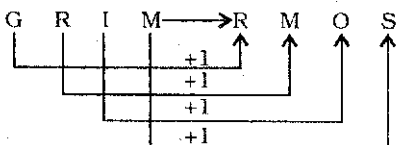

Similarly,

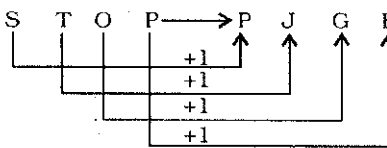

8. (1) $R > P > Q > S > T$
P scored the second highest marks.

9. (3)

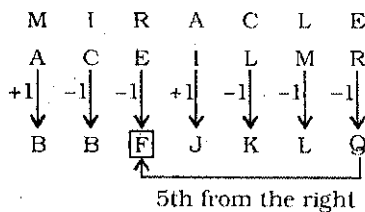

10. (5)

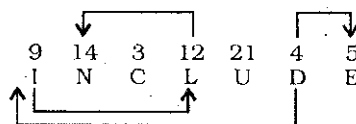

11. (2) $A \geq E = O > I$

$I < E = O < U$

Conclusions

I. $A \geq U$: Not True

II. $U > I$: True

12. (1) $G \leq B < C = D < F$

$G \leq B < C = D \geq E$

Conclusions

I. $F > E$: True

II. $G \geq E$: Not True

13. (4) $U \geq T > P = Q > R \leq S$

Conclusions

I. $U \geq R$: Not True

II. $T < S$: Not True

14. (5) $H > J \geq I < K = L$

Conclusions

I. $I < H$: True

II. $L > I$: True

15. (2) $M > N = O \leq P \leq R$

$M > N = O \geq Q$

Conclusions

I. $M \geq Q$: Not true

II. $R \geq N$: True

(16-20):

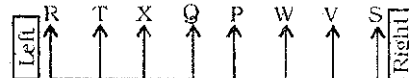

16. (4) V is third to the right of Q.

17. (1) R and S are seated at the two extreme ends of the line.

18. (3) Three persons - T, X and Q - are seated between R and P.

19. (5) T is second from the left end and V is second from the right end.

Q is fourth from the left end and P is fourth from the right end.

X is third from the left end and W is third from the right end.

20. (2) Fifth from the left ⇒ P

Sixth from the right ⇒ X

X Q P

(21-25):

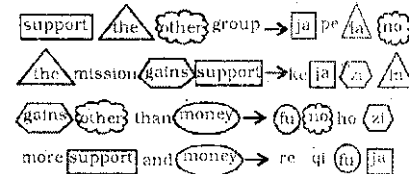

21. (2) The code for 'group' is 'pe'.

22. (5) 'zi' stands for 'gains'.

23. (1) more ⇒ re or qi

than ⇒ ho

the ⇒ la

group ⇒ pe

24. (3) The code for 'mission' is 'ke'.

25. (1) money ⇒ fu

more ⇒ re or qi

The code for 'matters' may be 'bu'.

(26-32) :

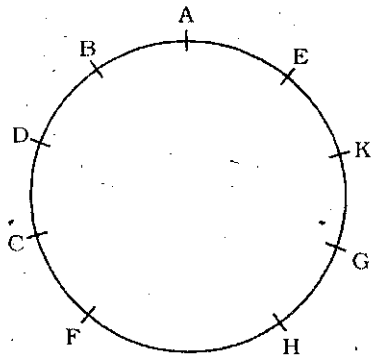

- 26. (4) F is third to the right of B.
- 27. (4) F and G are immediate neighbours of H.
- 28. (2)

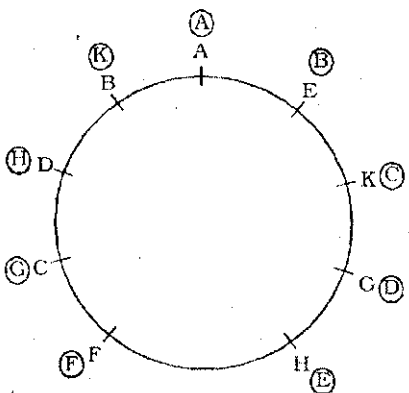

- 29. (1) H is second to the right of C.
B is second to the right of E.
G is second to the right of F.
- 30. (3) DC, DB ⇒ Immediate neighbours of D.
DF, DA ⇒ F is second to the right of D.
A is second to the right of D.
Therefore, ? = DH
H is is third to the right of D.
- 31. (2) G sits third to the left of A.
- 32. (5) Immediate neighbours of C are D and F.
- 33. (4)

S F U A * M @ S Q % N K & L Z C # V β W E
 11th from the left end

- 34. (2) A $\xrightarrow{+1}$ * $\xrightarrow{-2}$ U
 L $\xrightarrow{-1}$ 9 $\xrightarrow{+2}$ Z
 # $\xrightarrow{+1}$ V $\xrightarrow{-2}$ C
 K $\xrightarrow{+1}$ 5 $\xrightarrow{-2}$ N
 S $\xrightarrow{+1}$ Q $\xrightarrow{-2}$ @

35. (2)

Number	Symbol	Letter
--------	--------	--------

There is only one such combination ⇒

4	β	W
---	---	---

36. (1)

S $\xrightarrow{+3}$ U $\xrightarrow{+4}$ M $\xrightarrow{+5}$ % $\xrightarrow{+6}$ 5 $\xrightarrow{+7}$ V
 F $\xrightarrow{+3}$ A $\xrightarrow{+4}$ @ $\xrightarrow{+5}$ 6 $\xrightarrow{+6}$ & $\xrightarrow{+7}$ 4

37. (5) 7th to the right of 20th from the right end means 13th from the right, i.e., K.

38. (5) From both the statements

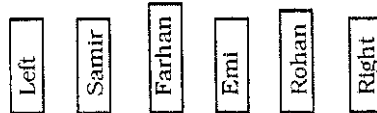

39. (4) From both the statements

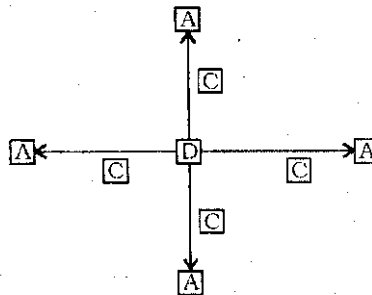

40. (5) From both the statements

Farewell was scheduled on 28th.

41. (3) From Problem Figure (1) to (2) the entire design is inverted and the pattern of one triangle is changed. Again, the black dot moves one step in clockwise direction and the white circles move in anticlockwise direction and one more white circle appears. Similar changes occur from Problem Figure (3) to (4) and from Problem Figure (5) to Answer Figure.

42. (4) From Problem Figure (1) to (2) the design (Z) moves one-half step in anticlockwise direction, the lower design also move one-half step in anticlockwise direction and it is replaced with a new design. The two pairs of adjacent smaller designs interchange positions. Similar changes occur from Problem Figure (3) to (4) and from Problem Figure (5) to Answer Figure.

43. (2) The following changes occur in the subsequent figures :

- (1) to (2) (2) to (3)
- (3) to (4) (4) to (5)
- (5) to (6)

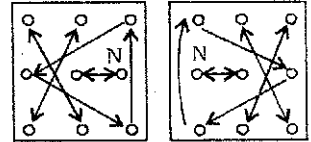

44. (1) The following changes occur in the subsequent figures :

- (1) to (2) (2) to (3)
- (3) to (4) (4) to (5)
- (5) to (6)

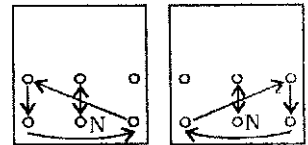

45. (5) In each subsequent figure the triangle and the star move one step in anticlockwise direction, the plane of other three designs rotates through 90° anticlockwise, the third design becomes the first design and the second design moves to the third position and it is replaced with a new design.

46. (3) In each subsequent figure the star, the circle and the square move one step in clockwise direction, the design (T) moves one step in clockwise direction and it is replaced with a new design, the triangle moves up and down after every two figures and the arrow moves from left to right and vice-versa after every two figures.

47. (4) From Problem Figure (1) to (2) one line segment rotates through 135° clockwise while the other line segment rotates through 45° anticlockwise, the three designs move in clockwise direction and the fourth design is replaced with a new design. Similar changes occur from Problem Figure (3) to (4) and from Problem Figure (5) to Answer Figure.

48. (5) From Problem Figure (1) to (2) the upper two designs interchange positions and the third design moves to the opposite sector and it is replaced with a new design. Similar changes occur from Problem Figure (3) to (4) and from Problem Figure (5) to Answer Figure.

49. (1) In each subsequent figure the plane of designs rotates through 45° clockwise, the last design becomes the first design and the design which moves to the last position is replaced with a new design.

50. (1) In each subsequent figure the first design moves to the second position and gets inverted, the third design moves to the first position and gets inverted, the second design moves to the fourth position and gets inverted while the fourth design moves to the third position.

$$51. (5) \left(72 - 748 \times \frac{1}{17}\right)^2 = ?^2 \times 4$$

$$\Rightarrow (72 - 44)^2 = ?^2 \times 4$$

$$\Rightarrow (28)^2 = ?^2 \times 4$$

$$\Rightarrow ?^2 = \frac{28 \times 28}{4} = 28 \times 7$$

$$\therefore ? = \sqrt{28 \times 7} = 7 \times 2 = 14$$

$$52. (3)$$

$$1 + \frac{3}{11} - 1 - \frac{1}{5} = ? - 2 - \frac{1}{10} + 1 + \frac{3}{4}$$

$$\Rightarrow \frac{3}{11} - \frac{1}{5} = ? - 1 - \frac{1}{10} + \frac{3}{4}$$

$$\Rightarrow ? = 1 + \frac{3}{11} - \frac{1}{5} + \frac{1}{10} - \frac{3}{4}$$

$$= 1 + \frac{60 - 44 + 22 - 165}{220}$$

$$= 1 - \frac{127}{220} = \frac{220 - 127}{220} = \frac{93}{220}$$

$$53. (4) \frac{(0.027)^2}{(0.09)^5} \times (0.0081) = (0.3)^{?+4}$$

$$\Rightarrow \frac{((0.3)^3)^2}{((0.3)^2)^5} \times (0.3)^4 = (0.3)^{?+4}$$

$$\Rightarrow \frac{(0.3)^6}{(0.3)^{10}} \times (0.3)^4 = (0.3)^{?+4}$$

$$\begin{cases} (a^m)^n = a^{mn}; \\ a^m \times a^n = a^{m+n}; \\ a^m \div a^n = a^{m-n} \end{cases}$$

$$\Rightarrow (0.3)^{6+4-10} = (0.3)^{?+4}$$

$$\Rightarrow ? + 4 = 0 \Rightarrow ? = -4$$

54. (1)

$$? = 1150 \times \frac{44}{100} \times \frac{35}{100} + \frac{700 \times 20}{100}$$

$$= 177.1 + 140 = 317.1$$

55. (5) $(?)^2 = 16 \times 7 + 361 + 11$

$$= 112 + 361 + 11 = 484$$

$$\therefore ? = \sqrt{484} = \pm 22$$

56. (2) $19000 \div 90 \times 30 \approx ? \times 30$

$$\Rightarrow \frac{19000 \times 30}{90 \times 30} \approx ? \Rightarrow ? \approx 211$$

\therefore Required answer = 220

57. (4) $? \approx \frac{1200}{90} + \frac{40}{2200} \times \frac{110}{400}$

$$= \frac{1200}{90} \times \frac{2200}{40} \times \frac{110}{400} \approx 200$$

\therefore Required answer = 190

58. (1) $? \approx (11)^3 + (14)^2 - (19)^2$

$$\approx 1331 + 196 - 361$$

$$= 1166$$

\therefore Required answer = 1170

59. (5) $94 \times 67 \div 47 \approx \frac{?}{8}$

$$\Rightarrow ? \approx \frac{94 \times 67 \times 8}{47} \approx 1072$$

\therefore Required answer = 1060

60. (2)

$$\frac{900 \times 81}{100} - 121 \approx ? - \frac{700 \times 41}{100}$$

$$\Rightarrow 729 - 121 \approx ? - 287$$

$$\Rightarrow 608 \approx ? - 287$$

$$\Rightarrow ? \approx 608 + 287 \approx 895$$

\therefore Required answer = 890

61. (4) The pattern of the number series is :

$$12 + 23 = 35$$

$$35 + 5 = 40$$

$$40 + 23 = 63$$

$$63 + 5 = 68$$

$$68 + 23 = \boxed{91}$$

62. (1) The pattern of the number series is :

$$19 + 9 = 28$$

$$28 + 18 (= 2 \times 9) = 46$$

$$46 + 36 (= 2 \times 18) = 82$$

$$82 + 72 (= 2 \times 36) = 154$$

$$154 + 144 (= 2 \times 72)$$

$$= \boxed{298}$$

63. (3) The pattern of the number series is :

$$655 - 484 = 171 = 19 \times 9$$

$$484 - 351 = 133 = 19 \times 7$$

$$351 - 256 = 95 = 19 \times 5$$

$$256 - 199 = 57 = 19 \times 3$$

$$\therefore ? = 199 - 19 = \boxed{180}$$

64. (3) The pattern of the number series is :

$$21 + 7 = 28$$

$$28 + 19 (= 7 + 12) = 47$$

$$47 + 39 (= 19 + 20) = 86$$

$$86 + 67 (= 39 + 28) = 153$$

$$153 + 103 (= 67 + 36)$$

$$= \boxed{256}$$

65. (1) The pattern of the number series is :

$$1229 - 500 = 729 = 9^3$$

$$500 - 157 = 343 = 7^3$$

$$157 - 32 = 125 = 5^3$$

$$32 - 5 = 27 = 3^3$$

$$\therefore ? = 5 - 1^3 = 5 - 1 = \boxed{4}$$

66. (4) I. $(6 + x)^2 = x^2 + 3x$

$$\Rightarrow 36 + 12x + x^2 = x^2 + 3x$$

$$\Rightarrow 12x - 3x = -36$$

$$\Rightarrow 9x = -36$$

$$\Rightarrow x = \frac{-36}{9} = -4$$

II. $5y^2 + 3y + 4 = 4y^2 + 8$

$$\Rightarrow 5y^2 - 4y^2 + 3y + 4 - 8 = 0$$

$$\Rightarrow y^2 + 3y - 4 = 0$$

$$\Rightarrow y^2 + 4y - y - 4 = 0$$

$$\Rightarrow y(y + 4) - 1(y + 4) = 0$$

$$\Rightarrow (y - 1)(y + 4) = 0$$

$$\therefore y = 1 \text{ or } -4$$

67. (3) I. $8x^2 - 121 = 31$

$$\Rightarrow 8x^2 = 121 + 31 = 152$$

$$\Rightarrow x^2 = \frac{152}{8} = 19$$

$$\therefore x = \pm\sqrt{19}$$

II. $22y - 565 = 4y - 331$

$$\Rightarrow 22y - 4y = 565 - 331 = 234$$

$$\Rightarrow 18y = 234$$

$$\Rightarrow y = \frac{234}{18} = 13$$

68. (1) I. $\frac{9}{\sqrt{x}} + 2\sqrt{x} = 5\sqrt{x} + \frac{4}{\sqrt{x}}$

$$\Rightarrow 9 + 2\sqrt{x} \times \sqrt{x}$$

$$= 5\sqrt{x} \times \sqrt{x} + 4$$

$$\Rightarrow 9 + 2x = 5x + 4$$

$$\Rightarrow 5x - 2x = 9 - 4$$

$$\Rightarrow 3x = 5 \Rightarrow x = \frac{5}{3}$$

$$\text{II. } y^3 \times y^{\frac{1}{2}} = \left(\frac{4}{3}\right)^{\frac{7}{2}}$$

$$\Rightarrow y^{\frac{7}{2}} = \left(\frac{4}{3}\right)^{\frac{7}{2}}$$

$$\Rightarrow y = \frac{4}{3}$$

69. (5) I. $5x + 23 = 423$
 $\Rightarrow 5x = 423 - 23 = 400$

$$\Rightarrow x = \frac{400}{5} = 80$$

II. $26y - 140 = 1940$
 $\Rightarrow 26y = 1940 + 140 = 2080$

$$\Rightarrow y = \frac{2080}{26} = 80$$

70. (1) I. $\frac{34}{\sqrt{x}} - \frac{12}{\sqrt{x}} = 4\sqrt{x}$

$$\Rightarrow 34 - 12 = 4\sqrt{x} \times \sqrt{x}$$

$$\Rightarrow 4x = 22$$

$$\Rightarrow x = \frac{22}{4} = 5.5$$

II. $\frac{6\sqrt{y}}{16} - \frac{4\sqrt{y}}{16} = \frac{1}{2\sqrt{y}}$

$$\Rightarrow 6\sqrt{y} - 4\sqrt{y} = \frac{16}{2\sqrt{y}}$$

$$\Rightarrow 2\sqrt{y} = \frac{16}{2\sqrt{y}}$$

$$\Rightarrow 2\sqrt{y} \times 2\sqrt{y} = 16$$

$$\Rightarrow 4y = 16 \Rightarrow y = 4$$

71. (4) If the length of the rectangle be x cm, then

$$\text{Breadth} = \left(\frac{828}{x}\right) \text{ cm.}$$

$\therefore 2(\text{length} + \text{breadth}) = \text{Perimeter of rectangle}$

$$\Rightarrow 2\left(x + \frac{828}{x}\right) = 118$$

$$\Rightarrow x + \frac{828}{x} = 59$$

$$\Rightarrow x^2 - 59x + 828 = 0$$

$$\Rightarrow x^2 - 36x - 23x + 828 = 0$$

$$\Rightarrow x(x - 36) - 23(x - 36) = 0$$

$$\Rightarrow (x - 23)(x - 36) = 0$$

$$\Rightarrow x = 23 \text{ or } 36$$

Hence, side of the square

$$= 46 \text{ or } 72 \text{ cm}$$

\therefore Perimeter of square = 4×46

$$= 184 \text{ cm}$$

or, $4 \times 72 = 288 \text{ cm}$

72. (1) Speed of the first athlete

$$= \frac{300}{50} = 6 \text{ m/sec.}$$

Speed of the second athlete

$$= 6 \times \frac{4}{3} = 8 \text{ m/sec.}$$

Speed of the third athlete

$$= 8 \times \frac{5}{4} = 10 \text{ m/sec.}$$

\therefore Distance covered by third athlete in 40 seconds

$$= 40 \times 10 = 400 \text{ metre}$$

73. (1) Vipin's present age

$$= 60 - 10 = 50 \text{ years}$$

Jyoti's present age

$$= \frac{12}{25} \times 50 = 24 \text{ years}$$

\therefore Amit's present age

$$= 24 + 5 - 3 = 26 \text{ years}$$

74. (3) Smallest angle of triangle

$$= 36 - 3 = 33^\circ$$

$$\therefore 4x + 3x = 180 - 33$$

$$\Rightarrow 7x = 147$$

$$\Rightarrow x = \frac{147}{7} = 21$$

\therefore Largest angle = $4x = 4 \times 21 = 84^\circ$

75. (4) Marks obtained by Pawan

$$= 1400$$

Marks obtained by Preeti

$$= 1400 - 205 = 1195$$

Marks obtained by Rohit

$$= 1195 + 280 = 1475$$

\therefore Marks obtained by Pramila

$$= 1475 - 195 = 1280$$

\therefore Pramila's percentage of marks

$$= \frac{1280}{1500} \times 100 \approx 85$$

76. (3) $6x + 5x + 7x + 2x = 360^\circ$

$$\Rightarrow 20x = 360^\circ$$

$$\Rightarrow x = 18^\circ$$

\therefore Largest angle of quadrilateral

$$= 7 \times 18 = 126^\circ$$

= Largest angle of triangle

\therefore Smallest angle of triangle

$$= 180^\circ - 126^\circ - 31^\circ = 23^\circ$$

77. (3) Second largest number

$$= 65 + 9^2$$

$$= 65 + 81 = 146$$

$$\text{Largest number} = 22^2 + 4^2$$

$$= 484 + 16 = 500$$

\therefore Smallest number

$$= 18^2 + 7^3 - 146 - 500$$

$$= 324 + 343 - 146 - 500$$

$$= 21$$

78. (5) First S.P.

$$= \frac{45000 \times 90}{100} = \text{Rs. } 40500$$

\therefore C.P. of second item

$$= \text{Rs. } 40500$$

Again, S.P. of second item

$$= \frac{40500 \times 115}{100} = \text{Rs. } 46575$$

\therefore Profit = $46575 - 45000$

$$= \text{Rs. } 1575$$

79. (2) Third number of set-A

$$= \frac{355}{5} = 71$$

Second number of set-B

$$= \frac{292}{4} - 1$$

$$= 73 - 1 = 72$$

\therefore Smallest even number of set-B

$$= 70$$

\therefore Required sum = $70 + 73$

$$= 143$$

80. (4) Principal = $\frac{\text{S.I.} \times 100}{\text{Time} \times \text{Rate}}$

$$= \frac{8000 \times 100}{4 \times 10} = \text{Rs. } 20000$$

$$\text{C.I.} = P \left[\left(1 + \frac{R}{100} \right)^T - 1 \right]$$

$$= 20000 \left[\left(1 + \frac{4}{100} \right)^2 - 1 \right]$$

- $$= 20000 \left[\left(\frac{26}{25} \right)^2 - 1 \right]$$
- $$= 20000 \left[\left(\frac{676}{625} - 1 \right) \right]$$
- $$= \frac{20000 \times 51}{625} = \text{Rs. } 1632$$
81. (2) Required percentage increase
- $$= \frac{10 - 4}{4} \times 100 = 150$$
82. (4) Average amount earned by person -A
- $$= \text{Rs. } \left(\frac{8 + 12 + 14 + 3 + 9 + 11}{6} \right)$$
- thousand
- $$= \text{Rs. } \left(\frac{57}{6} \right) \text{ thousand}$$
- $$= \text{Rs. } 9500$$
83. (1) Required ratio
- $$= 12 : 14 :: 4$$
- $$= 6 : 7 :: 2$$
84. (4) Required difference
- $$= (4 + 9 + 7 + 4 + 6 + 12 - 11) \times 1000$$
- $$= \text{Rs. } 31000$$
85. (3) Amount earned by all the three persons :
- January $\Rightarrow (8 + 4 + 9) \times 1000$
 $= \text{Rs. } 21000$
- March $\Rightarrow (14 + 7 + 10) \times 1000$
 $= \text{Rs. } 31000$
- \therefore Required percentage
- $$= \frac{21000}{31000} \times 100 \approx 68$$
86. (2) Average number of students from university-B in arts stream
- $$= \frac{544 + 123 + 321 + 124 + 338}{5}$$
- $$= \frac{1450}{5} = 290$$
87. (3) Difference between the number of science and arts students from university -D :
- Year 2006 $\Rightarrow 665 - 426 = 239$
 Year 2007 $\Rightarrow 736 - 220 = 516$
 Year 2008 $\Rightarrow 464 - 136 = 328$
 Year 2009 $\Rightarrow 502 - 222 = 280$
 Year 2010 $\Rightarrow 625 - 363 = 262$

88. (1) Required percentage
- $$= \frac{645}{455} \times 100 \approx 142$$
89. (4) Required ratio = 148 : 124
 $= 37 : 31$
90. (2) Required number of females
- $$= \frac{220 \times 60}{100} = 132$$
91. (3) Required number of tigers
- $$= 40 + 60 + 160$$
- $$= 260$$
92. (5) Required ratio
- $$= (120 + 80) : 140$$
- $$= 200 : 140 = 10 : 7$$
93. (2) Total number of tigers in sanctuary-C
- $$= 60 + 40 + 80 + 100 + 120$$
- $$= 400$$
- Total number of tigers in sanctuary -A in the years 2002 and 2008 together
- $$= 160 + 80 = 240$$
- \therefore Required percentage
- $$= \frac{400}{240} \times 100 \approx 167$$
94. (4) Required percentage increase
- $$= \frac{100 - 20}{20} \times 100 = 400\%$$
95. (5) Total number of tigers :
- Year 2002 $\Rightarrow 260$;
 Year 2004 $\Rightarrow 200$
 Year 2006 $\Rightarrow 300$
 Year 2008 $\Rightarrow 300$
 Year 2010 $\Rightarrow 360$
- Calculations (96 - 100) :**
- Science teachers
- $$\Rightarrow \frac{4000 \times 15}{100} = 600$$
- Maths teachers
- $$\Rightarrow \frac{4000 \times 3}{10} = 1200$$
- Hindi teachers
- $$\Rightarrow 1200 \times \frac{2}{3} = 800$$
- Social science teachers
- $$\Rightarrow \frac{1400 \times 12}{100} = 168$$
- English teachers $\Rightarrow 1400 - 168$
 $= 1232$

96. (3) Number of teachers of Hindi and English together
- $$= 800 + 1232 = 2032$$
97. (5) Required percentage
- $$= \frac{1200}{(800 + 600)} \times 100$$
- $$= \frac{1200}{1400} \times 100 = 86$$
98. (2) Required difference
- $$= 1232 - 168 = 1064$$
99. (4) Required number of female teachers
- $$= \frac{1800 \times 58}{100} = 1044$$
100. (5) Required ratio = 168 : 1200
 $= 21 : 150 = 7 : 50$
101. (4) Mrs. Sonia Gandhi
102. (5) Germany
- iq3. (3) The 6th Economic Census will be conducted, January to June in 2012. The 5th Economic Census was concluded in 2005.
104. (1) Post Offices can open ATMs
105. (4) India, Brazil and South Africa is member of 'IBSA'.
106. (3) Tamil Nadu
107. (4) China
108. (3) Ravi Bopara is a Indian origin Cricket player of Britain.
109. (4) West Indies
110. (4) Libya
111. (1) It is an an indigenously built LCA
112. (2) Chief Economic Advisor, GOI
113. (5) All (A), (B) and (C)
114. (3) Only (C)
115. (3) Only (C)
116. (2) Anti Money Laundering Act
117. (3) Essar Energy
118. (2) Mahatma Gandhi National Rural Employment Guarantee Act
119. (3) To make cities slum free across the country
120. (3) Department of Revenue
121. (1) It is the scheme by which unique number is issued by UID-AI to all Indian citizens
122. (2) The Comptroller and Auditor General
123. (3) Orissa
124. (3) On the last working day of Feb
125. (2) Euro

126. (1) Chairman, National Human Rights Commission
 127. (1) Chief Executive, ICC
 128. (4) 58
 129. (4) Financial Inclusion
 130. (2) OPEC
 131. (5) Speaker of the Lok Sabha
 132. (4) Demand & Supply
 133. (5) Booker Prize
 134. (4) SJGSY
 135. (2) 2009
 136. (4) 60 years
 137. (1) Swine Flu
 138. (3) National Water Resources Council was established in March'1983.
 139. (3) Six to fourteen years
 140. (1) Sikkim
 141. (4) Two Lives
 142. (3) Anita Desai has written the famous book 'The Village by the Sea'. It was published in 1982.
 143. (2) Bangladesh
 144. (5) One June 23, 2009, the World Bank has projected an 8 per cent growth for India in 2010.
 145. (5) 57.3 per cent
 146. (4) Commodity Certificates
 147. (5) Dinar
 148. (1) Dhyan Chand Trophy
 149. (3) Sports
 150. (5) 7.25 per cent
 151. (4) refuse 152. (3) increased
 153. (1) improve 154. (2) sound
 155. (4) cite 156. (5) lack
 157. (1) faced 158. (5) setback
 159. (3) very
 160. (2) taught
 161. (1) most memorable experience
 162. (5) No correction required
 163. (1) not last
 164. (3) so welcome as
 165. (3) had been leaked
 166. (2) B 167. (1) E
 168. (3) C 169. (1) A
 170. (4) D
 171. (1) niche-respect
 172. (1) liberating - but
 173. (3) sent - erroneously
 174. (4) plying - demanded
 175. (2) another - added'
 176. (3) The sentence shows past time. Hence, and saw all the guests screaming should be used.
 177. (5) No error
 178. (4) Here, that greet guests at the

venue..... should be used.

179. (3) Here, an inquiry committee which will have to be used. Who {Relative Pronoun} is used to show which person or people you mean.

Look at the sentence :

The people who called today want to buy the elephant.

180. (5) No error
 181. (2) Here, the valley that is should be used. If a building etc overlooks a place, you can see that place from the building.
 182. (2) Phrase **be/get caught up in something** means : to become involved in something, especially when you do not want to be. Hence, get caught up in meeting demands..... should be used here.

183. (4) Here, **a few people** should be

184. (4) Here, Present Simple i.e. as they treat their work time..... should be used.

185. (4) Here, with those of our families should be used.

186. (4) There are many market players or competitors who sell wares at extremely low prices.

187. (3) Give and take

188. (5) All (A), (B) and (C)

189. (4) Rural India contributes to half of the nation's income.

190. (3) Selling to Rural India

191. (3) Only (A)

192. (5) All (A), (B) and (C)

193. (4) Factual

194. (1) The meaning of the word **Feat (Noun)** as used in the passage is : an action or a piece of work that needs skill, strength or courage; task.

Look at the sentence :

The tunnel is a brilliant feat of engineering.

195. (2) The meaning of the word **Air (Verb)** as used in the passage is : to express your opinions publicly; voice.

Look at the sentence:

The weekly meeting enables employees to air their grievances.

196. (3) The meaning of the word **Rhetoric (Noun)** as used in the passage is : eloquence; oratory; speech or writing that is intend-

ed to influence people; lip service.

197. (1) The meaning of the word **Secure (Verb)** as used in the passage is : to obtain or achieve something; to protect; to acquire.

Look at the sentence :

The team managed to secure a place in the finals.

198. (5) Phrase **dry up** means : if supply of something dries up; there is gradually less of it until there is none left.

Phrase **Pick up** means : to get better, stronger etc; to improve; to continue.

Look at the sentence :

Sales have picked up 14% this year.

199. (2) The meaning of the word **Sizable (Adjective)** as used in the passage is : fairly large; considerable.

The word **Minuscule (Adjective)** means : extremely small.

200. (1) The meaning of the word **Lucrative (Adjective)** as used in the passage is : profitable; producing a large amount of money; making a large profit.

Its antonym should be **unprofitable**.